

**GERSTEL**

AppNote 2/2010

Determination of Trace Components Using a Selectable 1D/2D GC-MS System based on Capillary Flow Technology and Heart-Cut Fraction Collection

John R. Stuff, Jacqueline A. Whitecavage
*Gerstel Inc., 701 Digital Dr. Suite J,
Linthicum, MD 21090, USA*

Nobuo Ochiai, Kikuo Sasamoto
*Gerstel K.K., 2-13-18, Nakane, Meguro-ku,
Tokyo 152-0031, Japan*

KEYWORDS

Selectable 1D/2D GC-MS, SBSE, food, flavor, fragrance

ABSTRACT

Identification of important trace components in complex samples like fragrances, natural products, petroleum fractions or polymers can be challenging. Achieving the mass on column and resolution necessary to locate and identify trace components using a single chromatographic separation can be difficult if not impossible.

A selectable 1D/2D GC-MS configuration using Agilent capillary flow technology (CFT) and low thermal mass (LTM) GC column modules with dissimilar column phases was used to perform heartcutting 2D GC on two sample types. Stir Bar Sorptive Extraction was used as a solventless means to introduce sufficient mass of sample extract onto the precolumn of the multidimensional system. When additional mass is necessary to detect the analyte of interest in the second dimension separation, a selectable cryotrap after the precolumn can function as a fraction collector to accumulate fractions from many replicate chromatographic separations of the sample extract.

Separation and identification of selected trace components from beverages and consumer products were used to demonstrate the effectiveness of this system. The main advantages of this configuration were the simple selection of one or two dimensional operation and the ability to collect multiple fractions to maximize signal from trace components in the second dimension.

INTRODUCTION

Two dimensional or “heart-cut” gas chromatography is an effective tool for resolving components in a complex matrix. Typical systems use a non-selective detector, such as an FID, in the first dimension and a selective detector, such as an MSD, in the second. The system described below uses capillary flow technology from Agilent Technologies to allow mass spectrometry and a second detector for both first and second dimensional detection. The system requires no hardware changes for operation in either the one or two dimensional modes. Fraction collection was accomplished using a GERSTEL CryoTrap System (CTS 2). The first example shows the separation of buchu ketone, a key sulfur containing flavor component, from a peach flavor sample. The second example shows several components from gin.

EXPERIMENTAL

Instrumentation. Analyses were performed on a 6890 equipped with a 5975C inert XL MSD with triple axis detector and LTM Columns (Agilent Technologies), PTV inlet (CIS 4, GERSTEL), TDS 2/TDSA Thermal Desorption System (GERSTEL), and a CTS 2 Cryotrap (GERSTEL).

Sample preparation - Peach flavor sample: The sample was spiked to achieve a concentration of 1 µg/mL buchu ketone in the flavor. 200 µL of sample were pipetted into 10 mL screw cap headspace vials containing 9.8 mL bottled water to achieve a concentration of 0.02 µg/mL buchu ketone in 10 mL of solution.

Sample preparation - gin sample: 0.5 mL aliquots of sample were pipetted into 10 mL screw cap headspace vials containing 4.5 mL bottled water.

A conditioned Twister was added to the vials. The vials were screw capped, and the samples stirred at room temperature for 1 hour. Twisters were rinsed with water, blotted dry, and the samples were placed into conditioned TDS tubes for analysis.

Analysis conditions.

TDS 2: splitless
30°C; 60°C/min; 250°C (5 min)

CIS 4: glass wool packed liner
solvent venting 50 mL/min
split, 10:1 - peach flavor sample
splitless - gin sample
-150°C; 12°C/sec; 280°C (3 min)

Pneumatics: constant pressure

Oven: 250°C, held for duration

1st Column: 10 m Rtx-5 (Restek), LTM format
 $d_i = 0.18 \text{ mm}$ $d_f = 0.2 \text{ }\mu\text{m}$
40°C (1 min); 10°C/min;
260°C (0.8 min);
100°C/min; 40°C - peach flavor
40°C (1 min); 10°C/min; 160°C;
140°C/min; 300°C (3 min) - gin

CTS 2
-50°C (11.2 min); 20°C/s;
240°C (2 min), - peach flavor sample
-50°C (17 min); 20°C/s;
240°C (2 min) - gin sample

2nd Column: 10 m DB-Wax (Agilent), LTM format
 $d_i = 0.18 \text{ mm}$ $d_f = 0.18 \text{ }\mu\text{m}$
40°C (11.2 min); 20°C/min;
230°C (1.5 min); 50°C/min;
40°C - peach flavor sample
40°C (17 min); 10°C/min; 210°C;
170°C/min; 40°C - gin sample

MSD
full scan, 40-350 amu

RESULTS AND DISCUSSION

A diagram of the selectable 1D/2D GC-MS system configuration is shown in Figure 1. The performance of the system was illustrated by first identifying key flavor components in a peach flavor and a gin sample using the 1D configuration and then performing a heart cut of selected peaks from the first dimension separation onto

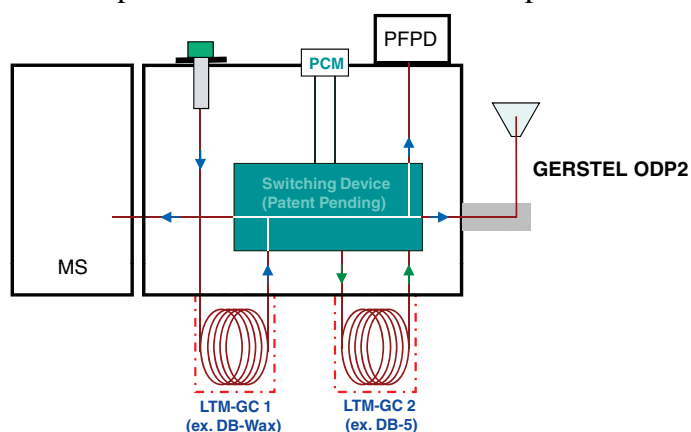

Figure 1. Diagram of the Selectable 1D/2D GC-MS setup.

the 2nd dimension column. Finally, enhancing the 2D signal using fraction collection and cryo-trap enrichment between the first and second dimension columns was demonstrated by comparing the resulting peak areas from desorption of 1 and 5 Twister respectively onto the system. Prior to desorption, each Twister had been used to extract equal sample volumes.

A control study using a standard prepared at a concentration of 0.1 $\mu\text{g}/\text{mL}$ was set up to identify the peak, confirm the retention time and assess the peak response of buchu ketone. Figure 2 shows the 1st dimension and 2nd dimension total ion chromatograms of the 0.1 $\mu\text{g}/\text{mL}$ buchu ketone standard using the selectable 1D/2D system and applying a heart cut from the 1st dimension column from 10.0-11.0 minutes. The absence of peaks in the heart cut region of the 1st dimension chromatogram is an indication that eluting compounds were transferred to the 2nd dimension column.

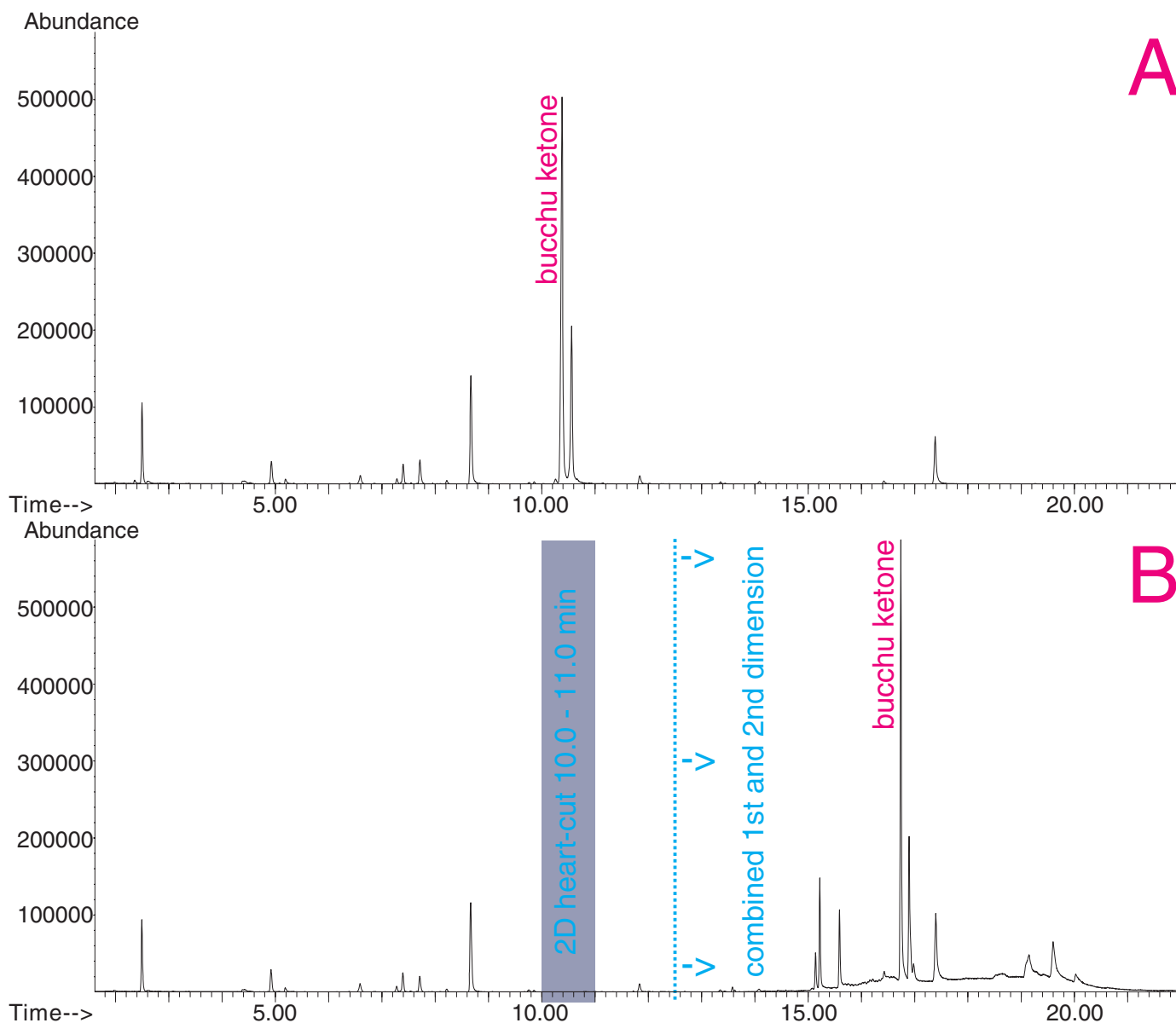

Figure 2. Stacked view TICs of the 1st dimension chromatogram (A) and the combined 1st and 2nd dimension chromatogram that results from heart-cut from 10-11 mins. Sample: 0.1 $\mu\text{g}/\text{mL}$ buchu ketone in water.

Figure 3 shows the 1st and 2nd dimension total ion chromatograms of the peach flavor sample using the selectable 1D/2D GC-MS system. A heart cut, from the 1st dimension column, was taken from 10.0-11.0 minutes. Several compounds from the heart cut region are identified in the 2nd dimension chromatogram. In this example, there is overlap of peaks from the 1st and 2nd dimension chromatograms towards the end of the chromatogram, where late eluting peaks from the 1st dimensional separation are observed. These late eluting peaks can easily be eliminated by backflushing the first column. In this example, we chose not to backflush the 1st dimension column since none of the peaks from the first dimension separation coeluted with those from the second dimension separation.

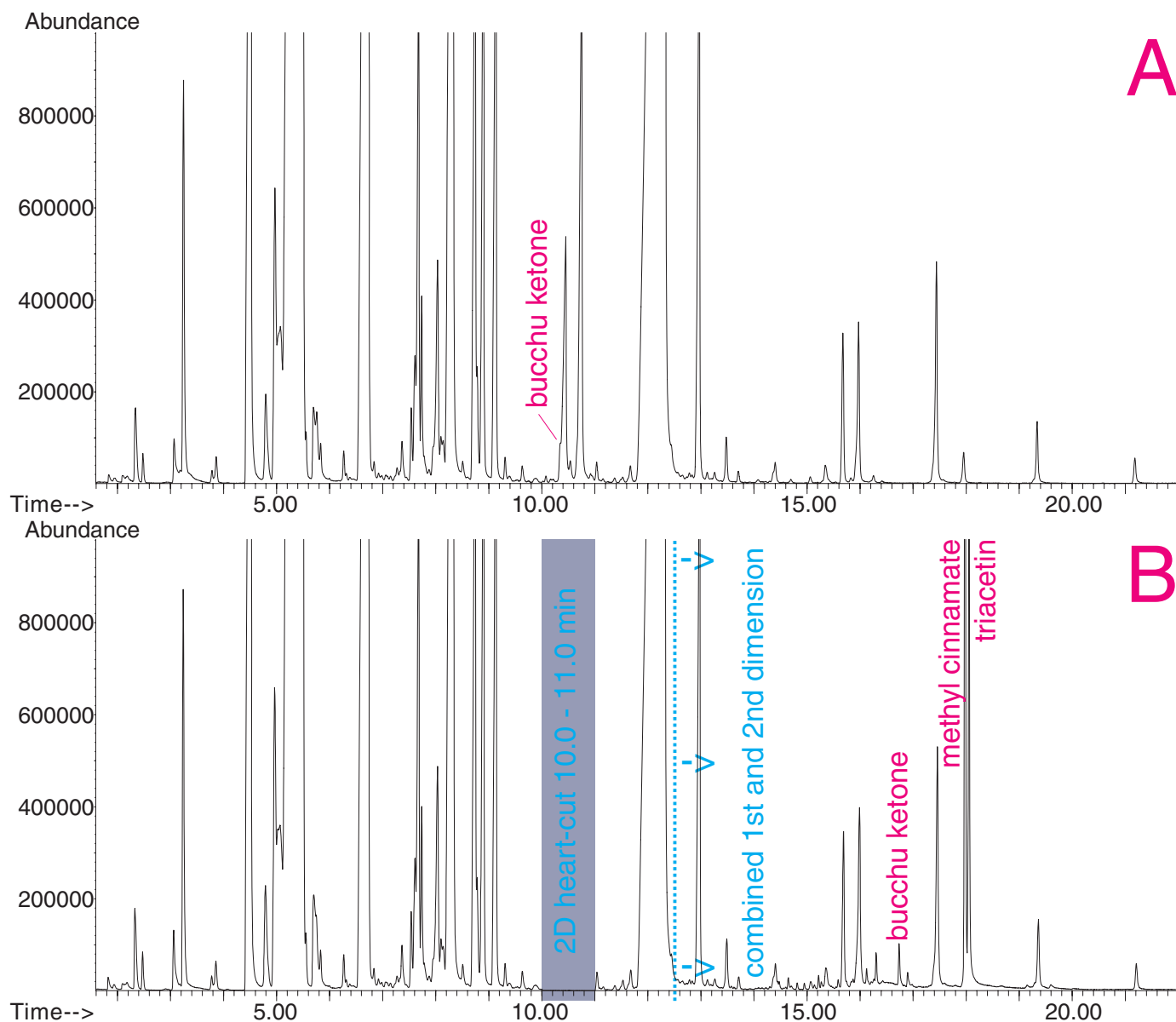

Figure 3. Stacked view peach flavor sample TICs of the 1st dimension chromatogram (A) and the combined 1st and 2nd dimension chromatogram that results from a heart-cut from 10–11 mins. (B).

In order to introduce additional mass of analyte on the second dimension column, a CryoTrap System (GERSTEL CTS 2) was used to accumulate fractions from 5 replicates of the sample introduction. At first, one Twister stir bar was desorbed and the designated heart-cut fraction from the first dimension separation was trapped in the CTS 2. Four more tubes, each containing one Twister, were subsequently desorbed and the same fraction from the designated heart-cut region collected in the CTS 2. During collection, the CTS was kept at -50°C in order to hold the fractions in the trap. After accumulating 5 replicate fractions, the CTS was heated to release the compounds, and the second dimension separation was performed.

Figure 4 shows the additional response obtained in the second column after accumulating the fractions from 5 Twister desorptions. The resulting peak areas are listed in Table 1. A 5.6 fold increase in signal response was seen indicating that the fraction collection worked properly.

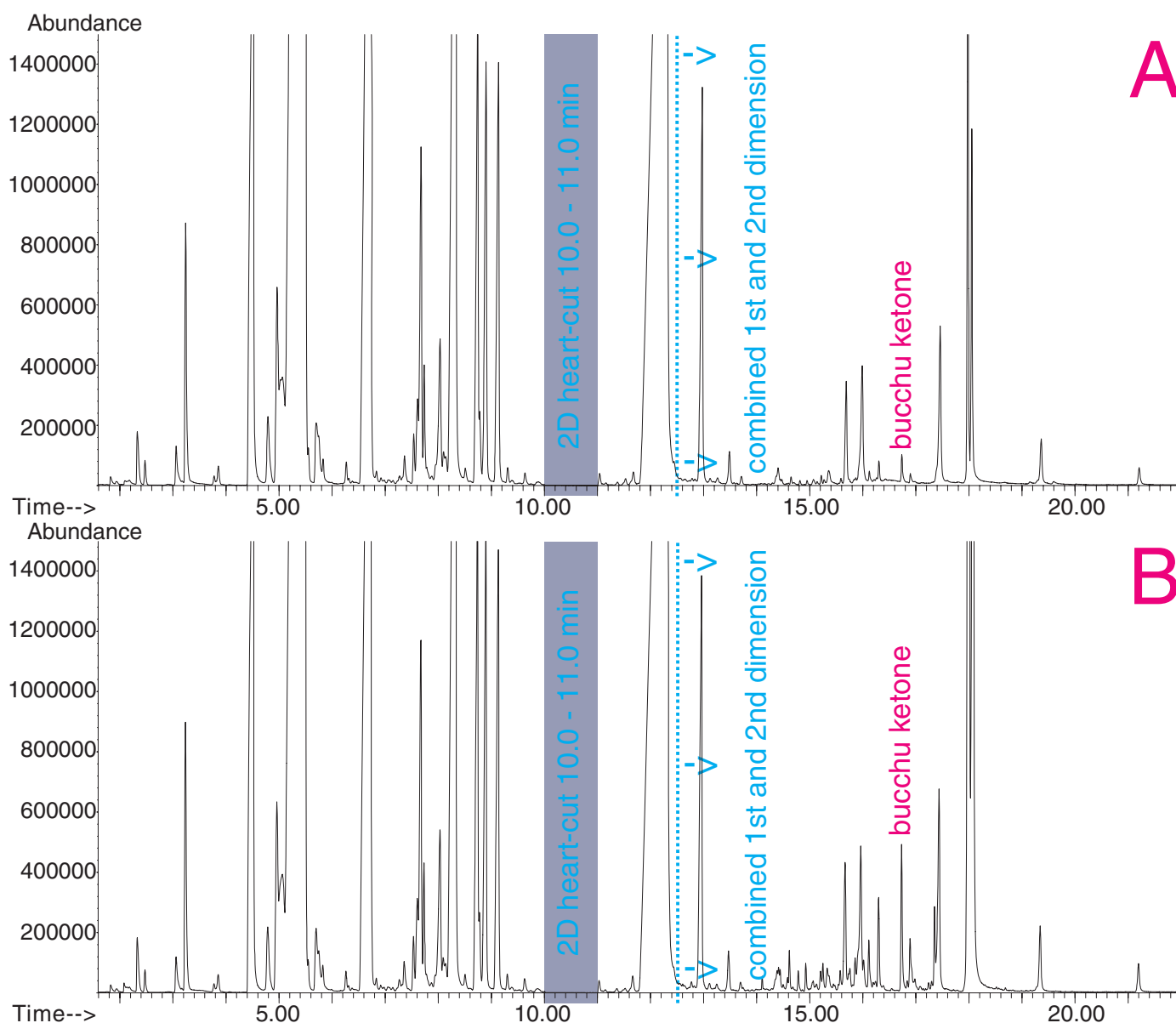

Figure 4. Stacked view peach flavor sample TICs resulting from the desorption of 1 (A) and 5 Twisters (B) respectively. Heart-cuts were performed between the 1st and 2nd column from 10–11 mins. The combined 1st and 2nd dimension (1D/2D) chromatograms are shown. In the bottom trace, the initial 1D part is from the 5th Twister desorption whereas the 2D chromatogram part results from accumulated heart-cuts from all five 1D runs.

Table 1. Increase in response subject to amount of Twisters used for desorption.

	Peak Area
1 Twister	1,535,403
5 Twisters	8,587,702

Figure 5 shows the total ion chromatogram of the gin sample 1D trace.

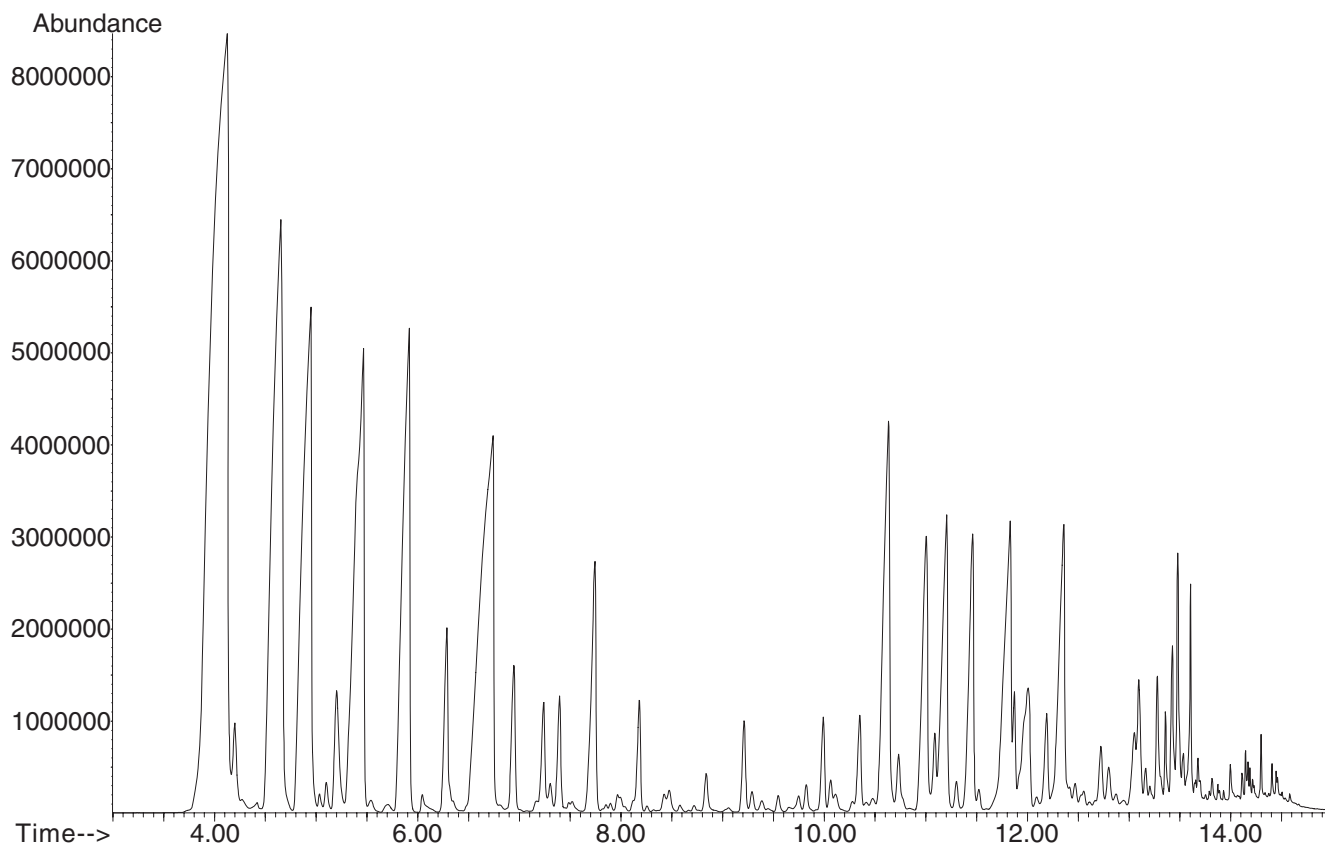

Figure 5. 1st dimension TIC of gin sample.

Figure 6 shows the total ion chromatograms of the gin sample using the 1D and 2D with heart cut (9.36-10.35 min) configuration.

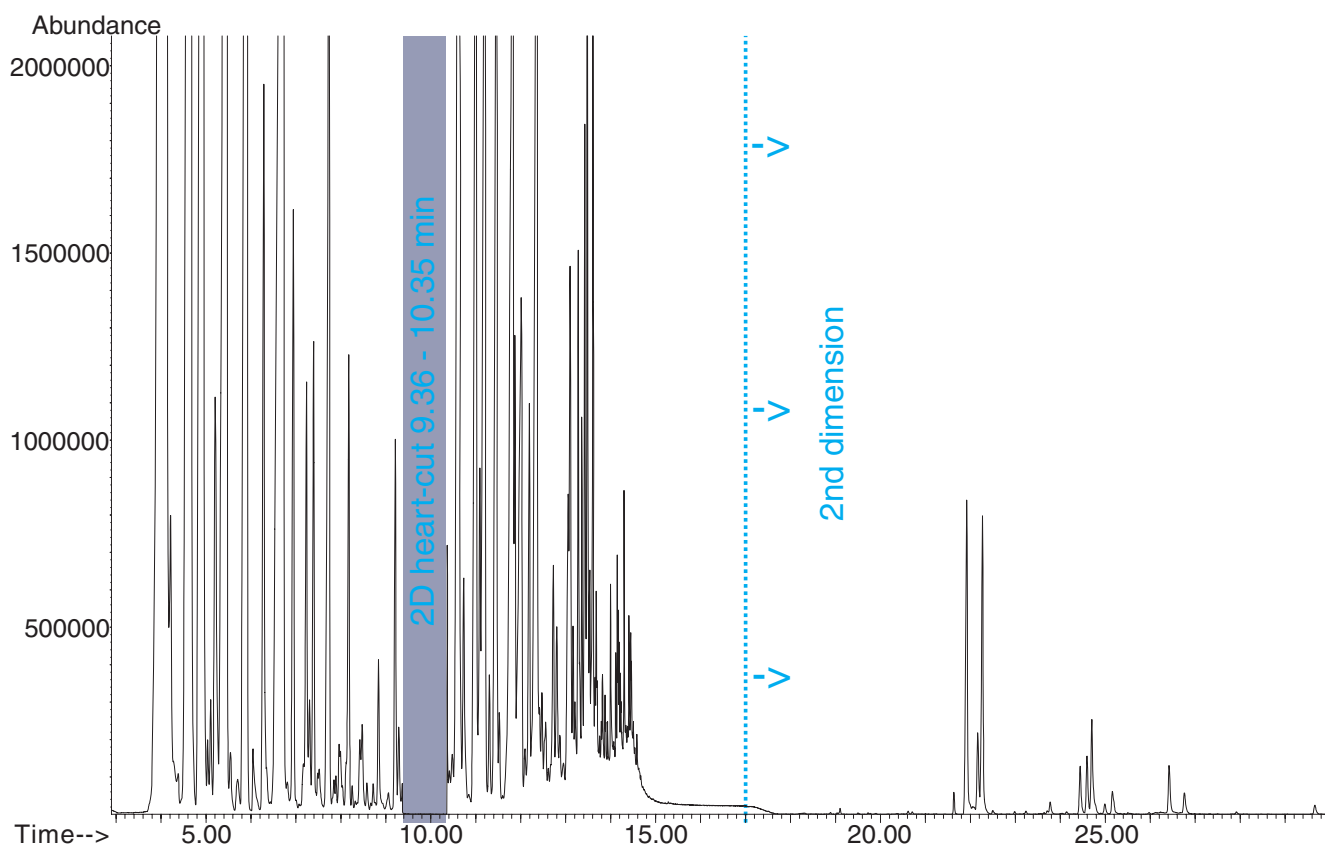

Figure 6. TIC of gin sample: Combined 1st and 2nd dimension chromatogram that results from a heart-cut from 9.36-10.35 mins.

Figure 7 shows total ion chromatograms of gin sample fractions trapped from 1 and 5 Twisters respectively. A five-fold increase in peak areas for the compounds labeled in the chromatogram was seen when performing the five-fold fraction collection.

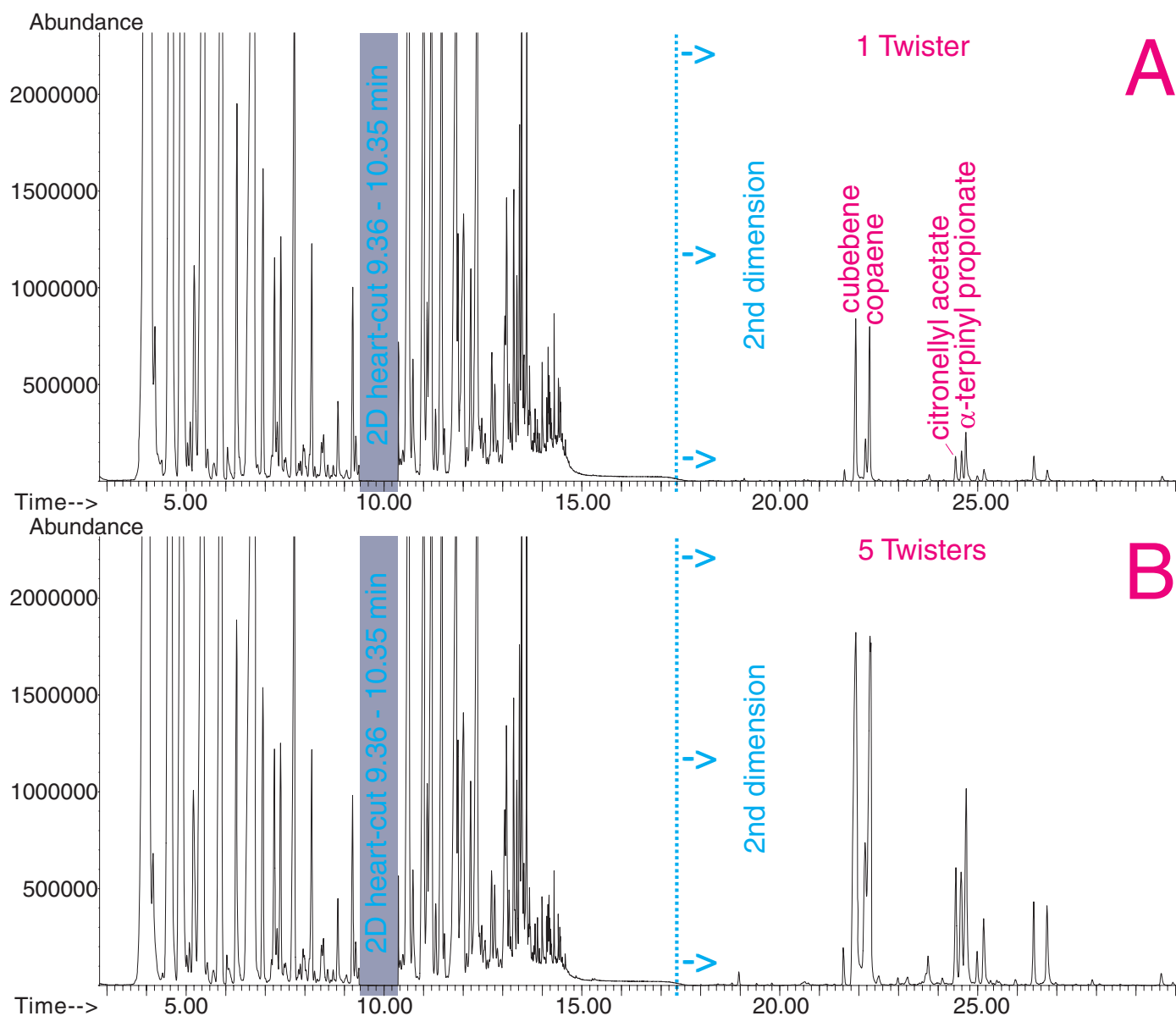

Figure 7. Stacked view gin sample TICs resulting from the desorption of 1 (A) and 5 Twisters (B) respectively. Heart-cuts were performed between the 1st and 2nd column from 9.36-10.35 mins. The combined 1st and 2nd dimension (1D/2D) chromatograms are shown. In the bottom trace, the initial 1D part is from the 5th Twister desorption whereas the 2D chromatogram part results from accumulated heart-cuts from all five 1D runs.

CONCLUSIONS

The selectable 1D/2D GC-MS system with a valve-less flow switching device and Gerstel CryoTrap System (CTS 2) is a powerful solution for the analysis of trace components in complex samples.

The main features of this system are the simple selection of one- or two dimensional operation as well as the ability to collect multiple fractions to maximize signal from trace components in the second dimension. The analysis method setup of the system is facilitated using GERSTEL 1D/2D Sync software, which calculates critical method parameters for the selected column set.



GERSTEL GmbH & Co. KG

Eberhard-Gerstel-Platz 1
45473 Mülheim an der Ruhr
Germany

- +49 (0) 208 - 7 65 03-0
- +49 (0) 208 - 7 65 03 33
- gerstel@gerstel.com
- www.gerstel.com

GERSTEL Worldwide

GERSTEL, Inc.

701 Digital Drive, Suite J
Linthicum, MD 21090
USA

- +1 (410) 247 5885
- +1 (410) 247 5887
- sales@gerstelus.com
- www.gerstelus.com

GERSTEL AG

Wassergrabe 27
CH-6210 Sursee
Switzerland

- +41 (41) 9 21 97 23
- gerstelag@ch.gerstel.com
- www.gerstel.ch

GERSTEL K.K.

1-3-1 Nakane, Meguro-ku
Tokyo 152-0031
SMBC Toritsudai Ekimae Bldg 4F
Japan

- +81 3 5731 5321
- +81 3 5731 5322
- info@gerstel.co.jp
- www.gerstel.co.jp

GERSTEL LLP

Level 25, North Tower
One Raffles Quay
Singapore 048583

- +65 6622 5486
- +65 6622 5999
- SEA@gerstel.com
- www.gerstel.com

GERSTEL Brasil

Av. Pascoal da Rocha Falcão, 367
04785-000 São Paulo - SP Brasil

- +55 (11)5665-8931
- +55 (11)5666-9084
- gerstel-brasil@gerstel.com
- www.gerstel.com.br

Information, descriptions and specifications in this Publication are subject to change without notice. GERSTEL, GRAPHPACK and TWISTER are registered trademarks of GERSTEL GmbH & Co. KG.

© Copyright by GERSTEL GmbH & Co. KG



Awarded for the
active pursuit of
environmental sustainability